

700*700*1900mm

800*800*1900mm

900*900*1900mm

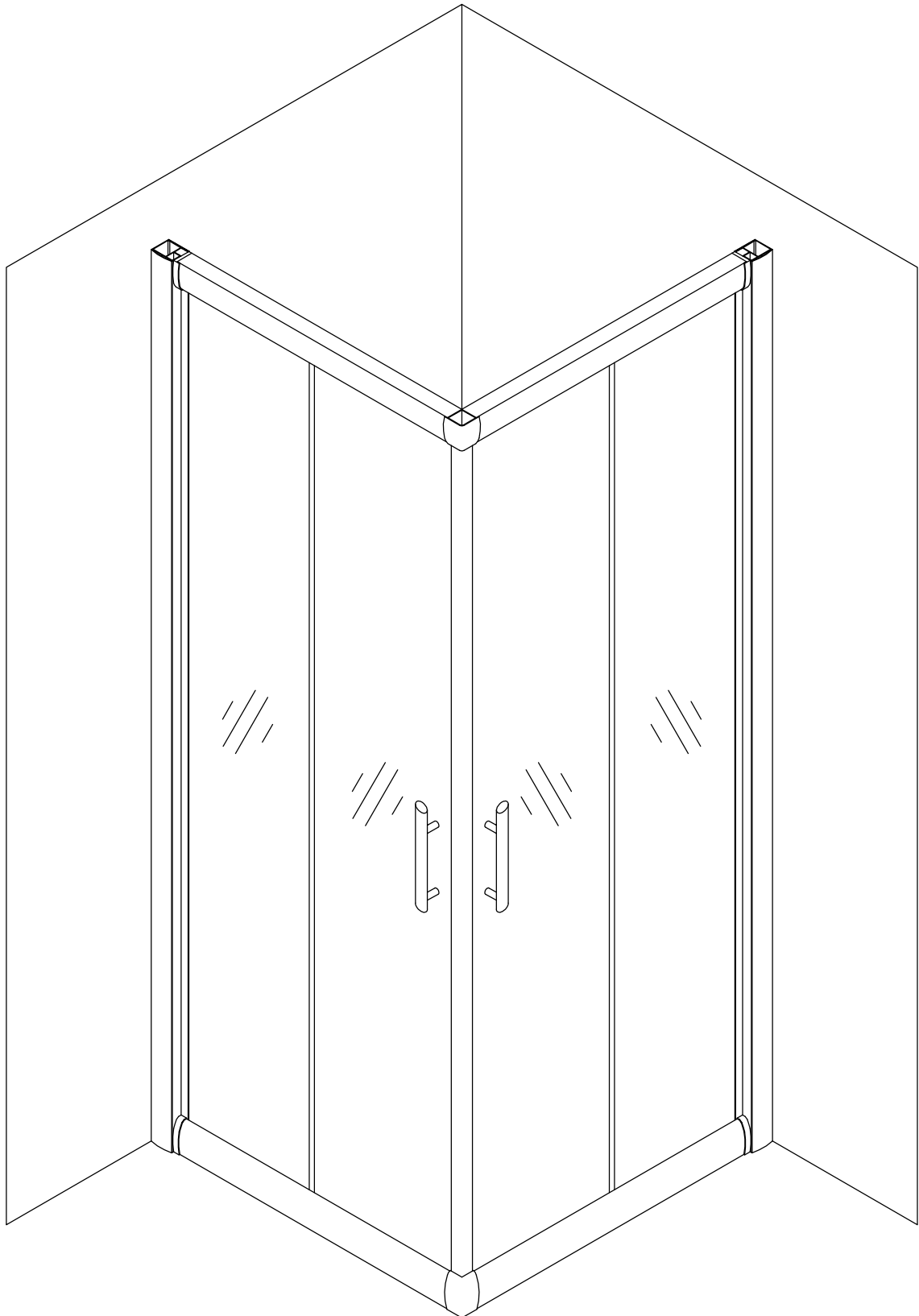

1

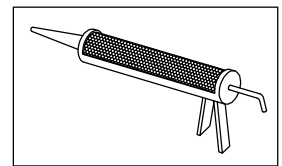
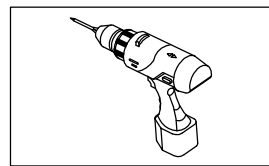
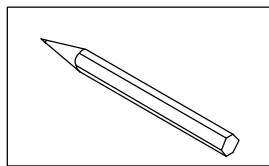
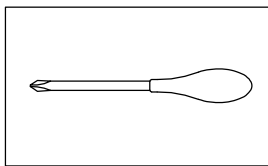
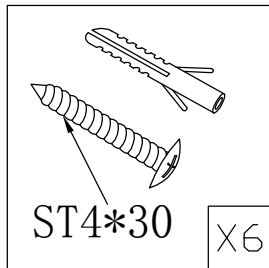
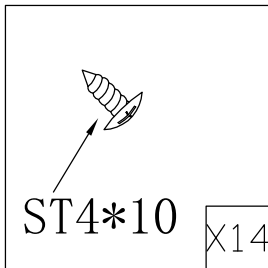
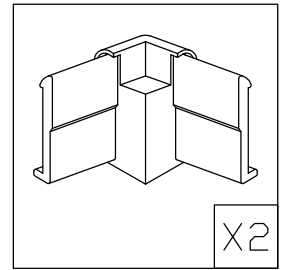
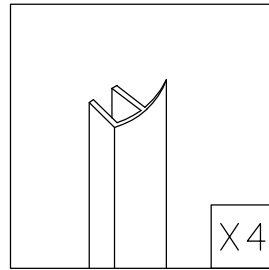
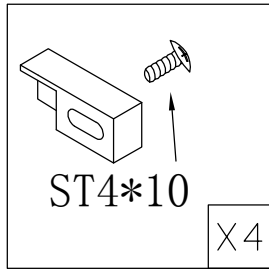
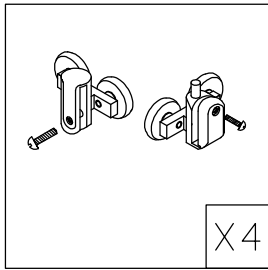
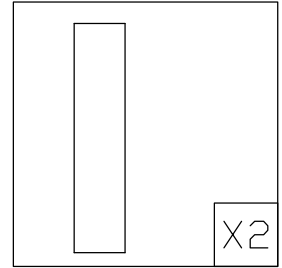
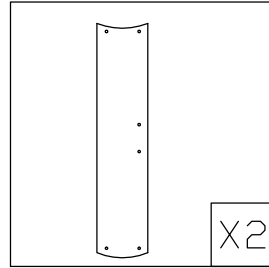
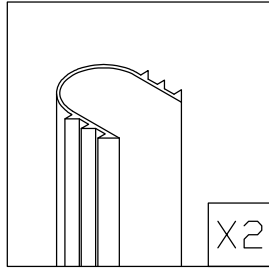
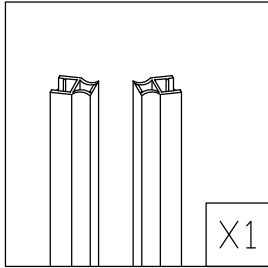
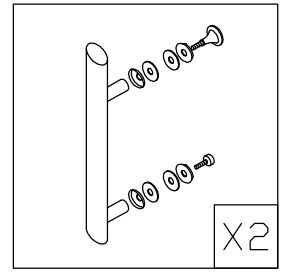
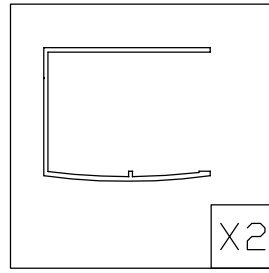
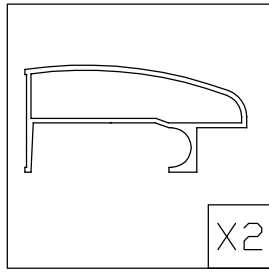
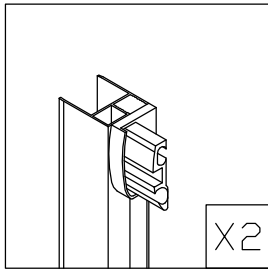

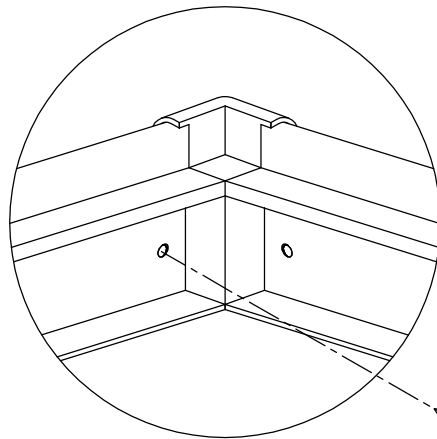
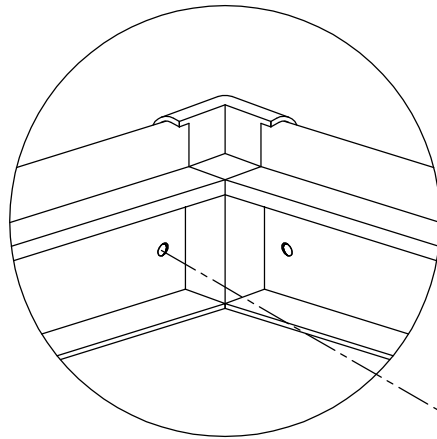
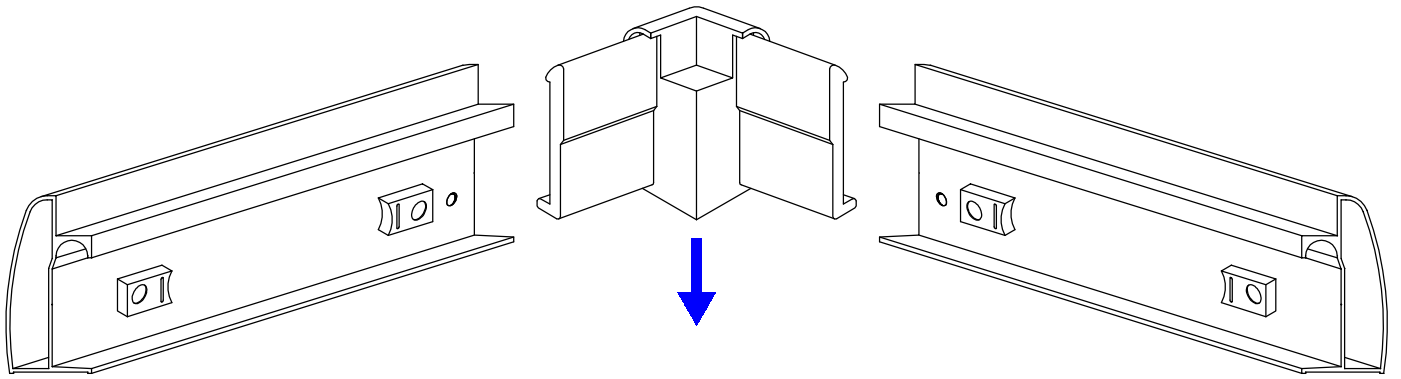
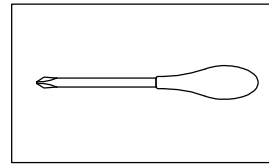
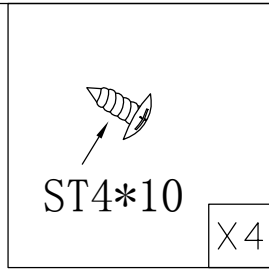
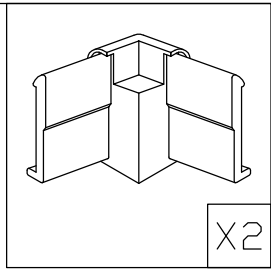
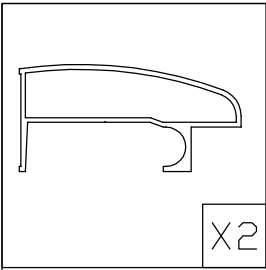

4- $\varnothing 2.8\text{mm}$

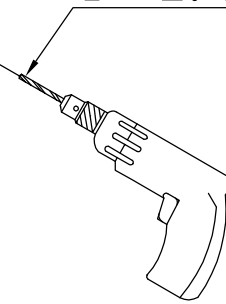

ST4*10

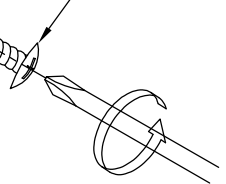

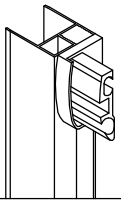

X2

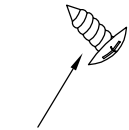

ST4*10

X4

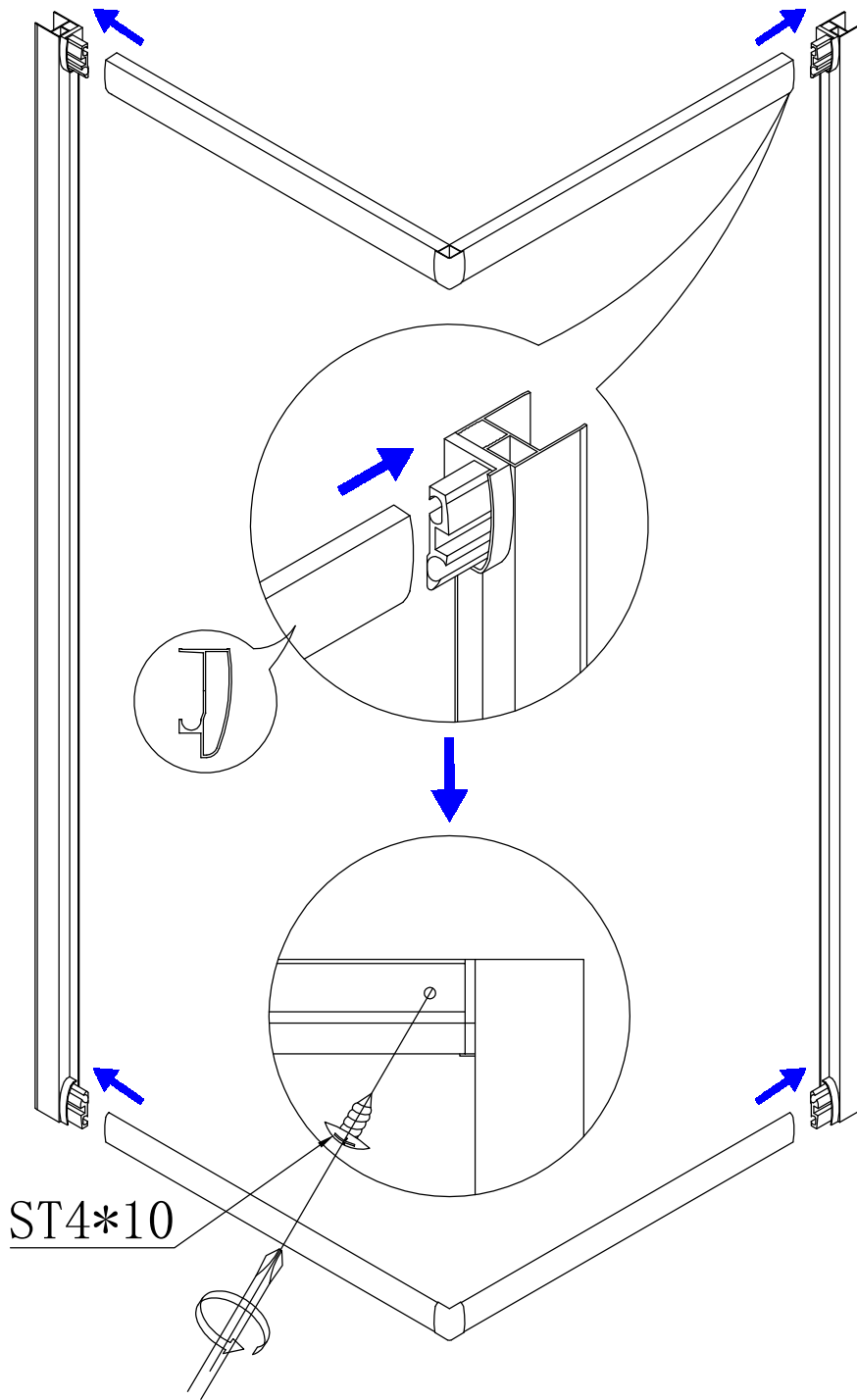

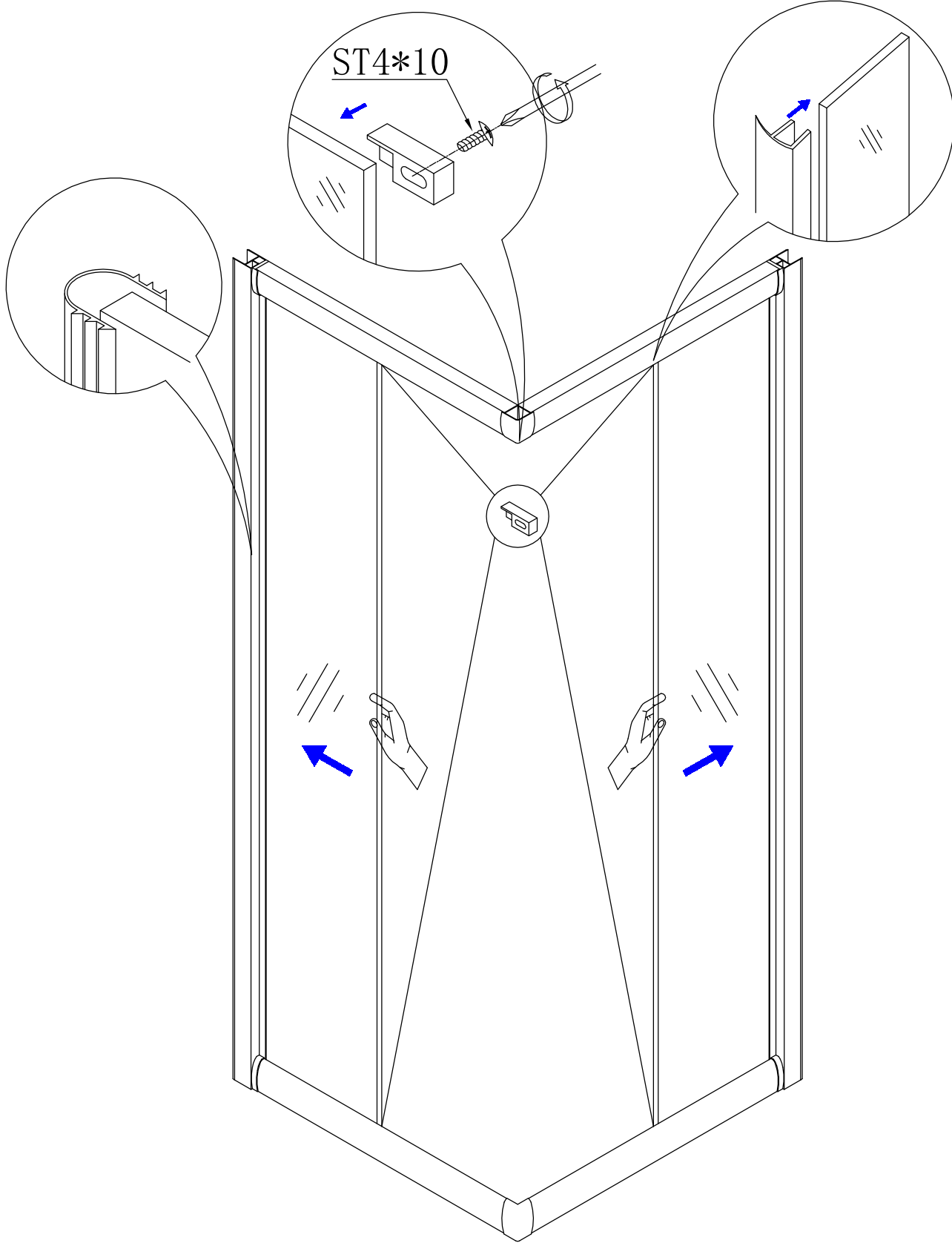
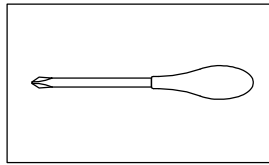
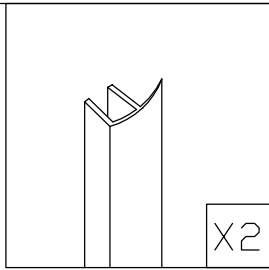
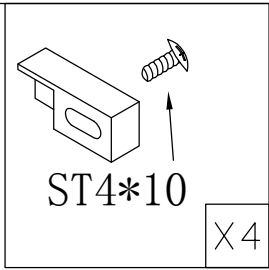
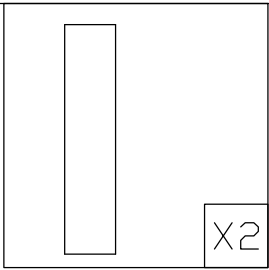
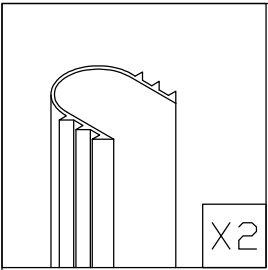

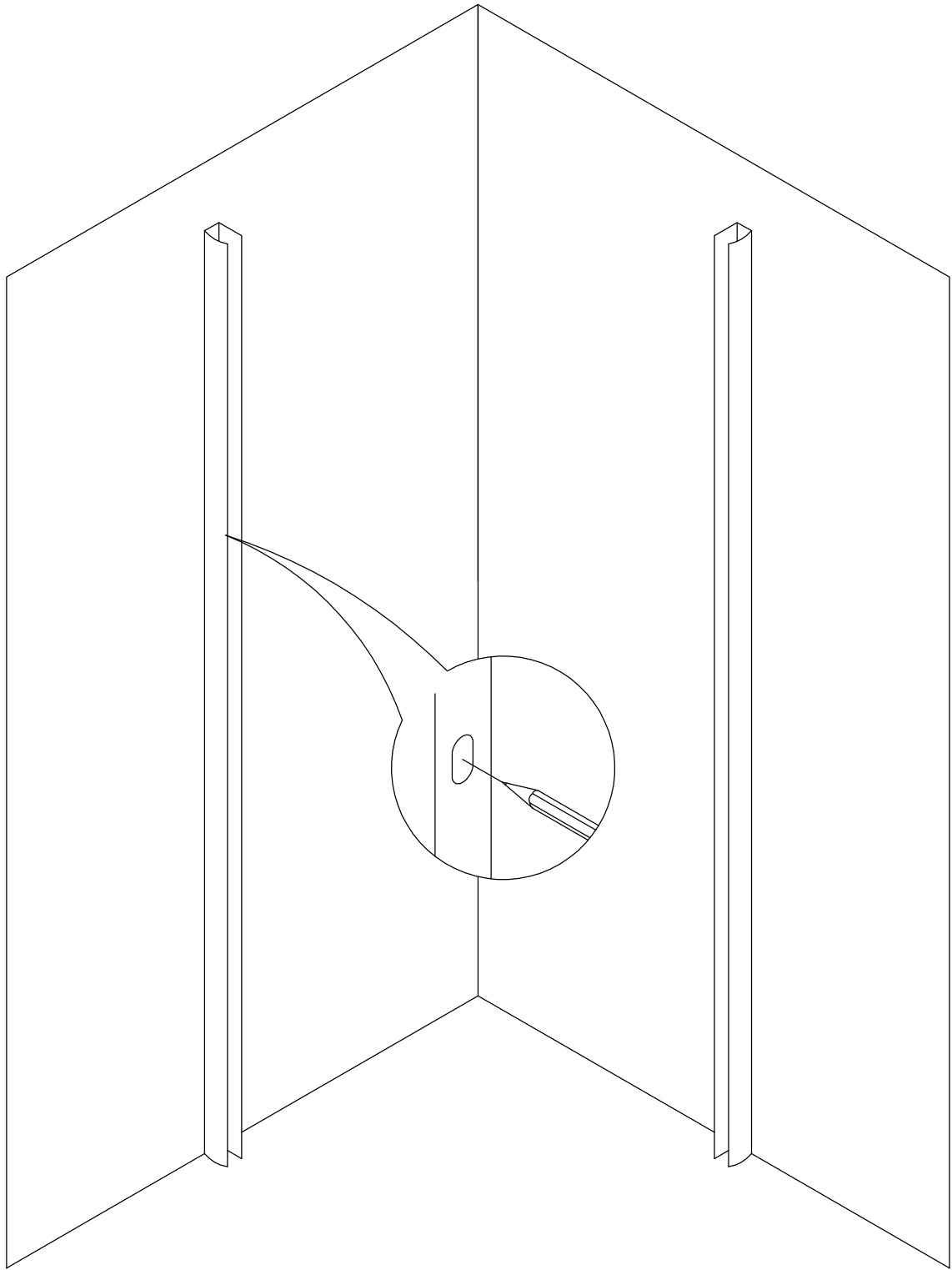
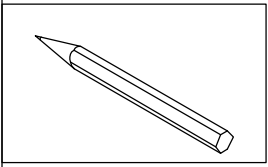

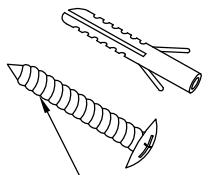

ST4*30

X6

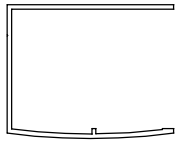

X2

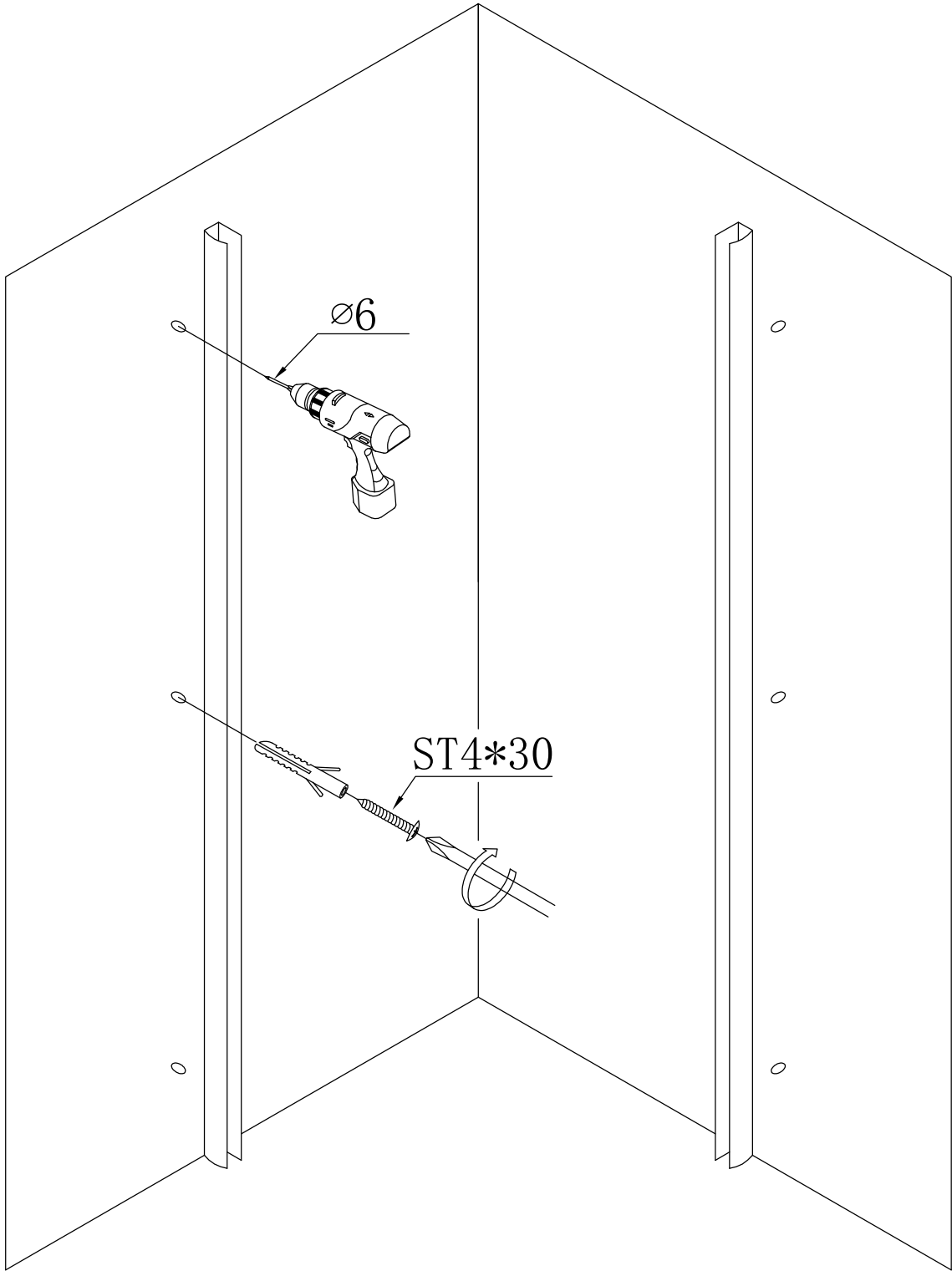
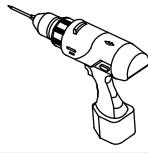

ST4*10

X6

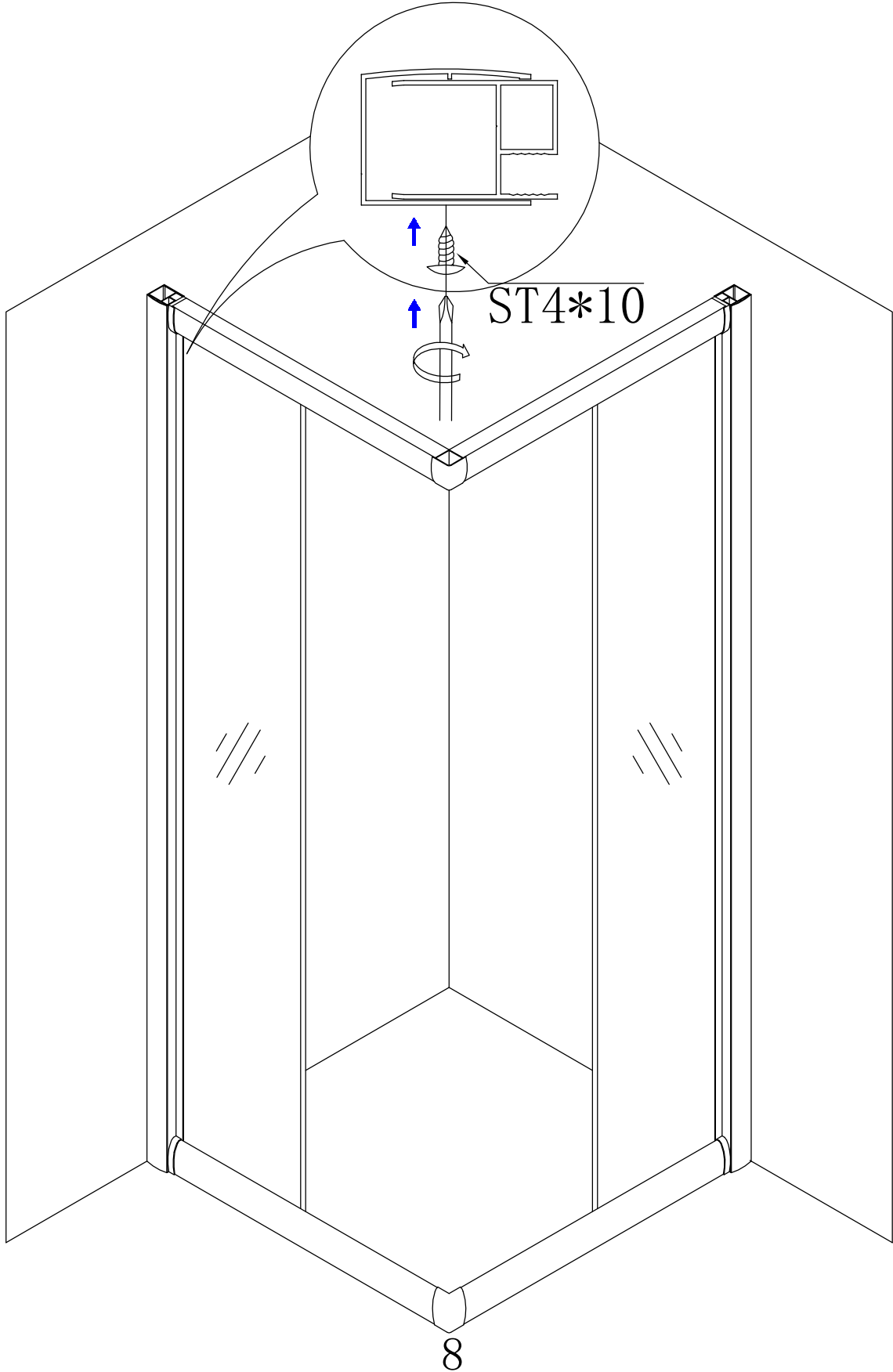
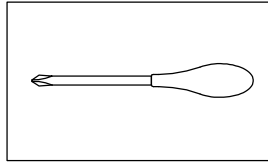
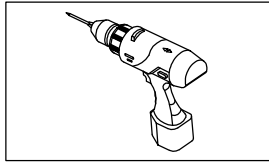

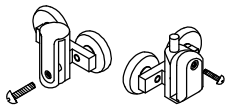

X4

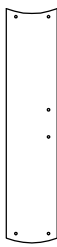

X2

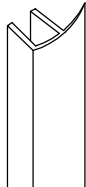

X2

